

HONDA CB750 HORNET '23-

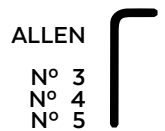



M O U N T I N G I N S T R U C T I O N S

REF 21481

ENGINE SPOILER

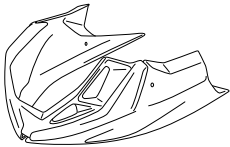
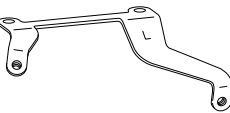
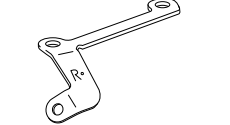
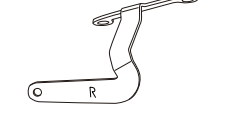

COMPATIBLE WITH ARROW EXHAUST

| ID | PIEZA/PART | DESCRIPCIÓN | DESCRIPTION | QTY | REF |
|----|---|-----------------------------------|--------------------------------|-----|-----------------|
| 1 |  | Quilla | Engine spoiler | 1 | 21481J/N/CM3 |
| 2 |  | Soporte izquierdo (L) | Left support (L) | 1 | SOP3P13--L21481 |
| 3 |  | Soporte delantero derecho (Rº) | Right front support (Rº) | 1 | SOP3P13-FR21481 |
| 4 |  | Soporte trasero derecho (R) | Right rear support (R) | 1 | SOP3P13-RR21481 |
| 5 |  | Silentblock Ø12xØ6x9 | Ø12xØ6x9 silentblock | 4 | AROPASACABLES-1 |
| 6 |  | Casquillo con valona Ø12xØ6,8x7,3 | Ø12xØ6,8x7,3 bush with flange | 4 | CASQUI-1A---750 |
| 7 |  | Tornillo Allen M5x16 Ø11 ISO 7380 | M5x16 Ø11 ISO 7380 Allen screw | 4 | TORNI-I7380-493 |
| 8 |  | Tapón tornillo M5 ISO 7380 | M5 ISO 7380 screw cap | 4 | TAPON-----85 |

* Algunos componentes se suministran montados.
Some components are supplied assembled.

HONDA CB750 HORNET '23-

INSTRUCCIONES DE MONTAJE - MOUNTING INSTRUCTIONS - MONTAGEANLEITUNG

1A

DISASSEMBLY
DESMONTAJE

WITH ORIGINAL EXHAUST

RIGHT SIDE

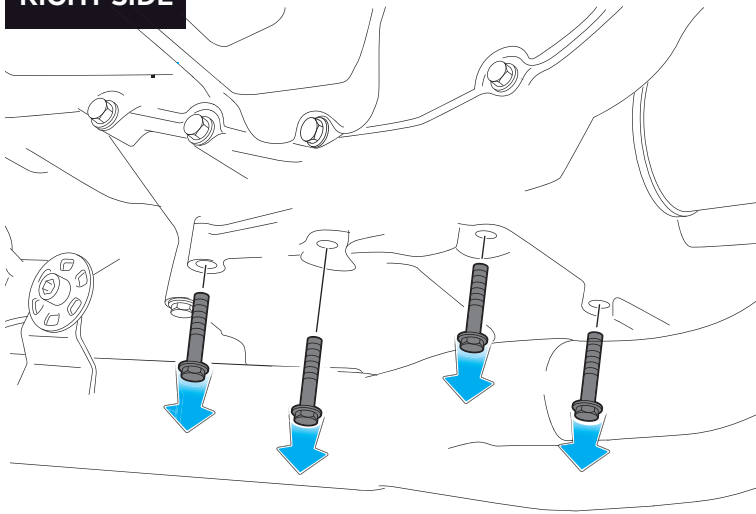

1B

DISASSEMBLY
DESMONTAJE

WITH ARROW EXHAUST

RIGHT SIDE

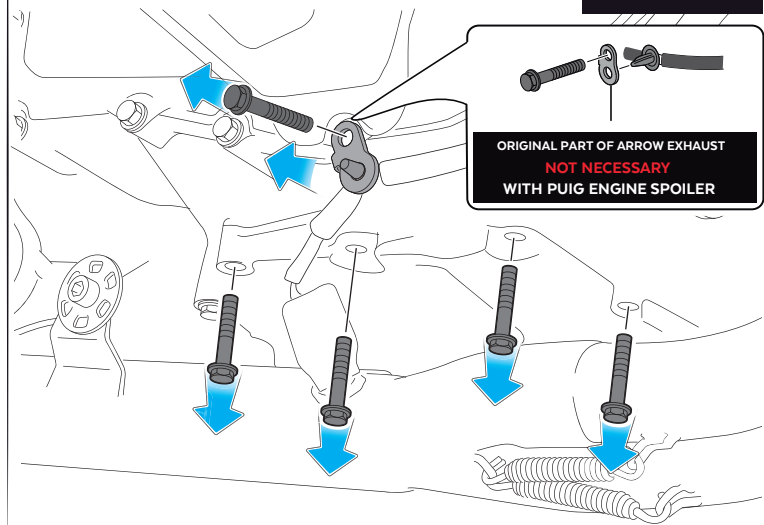

2

ASSEMBLY
MONTAJE

RIGHT SIDE

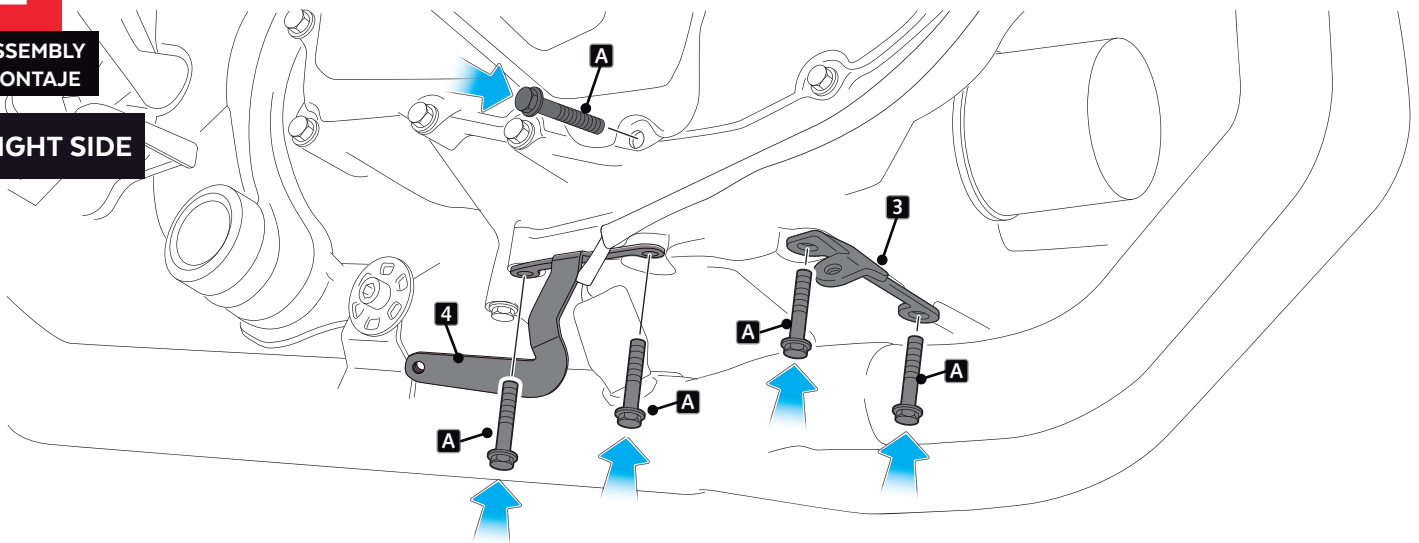

A Par Apriete - 10 Nm
Tightening Torque - 10 Nm

A PIEZA ORIGINAL
ORIGINAL PART

HONDA CB750 HORNET '23-

INSTRUCCIONES DE MONTAJE - MOUNTING INSTRUCTIONS - MONTAGEANLEITUNG

3

DISASSEMBLY
DESMONTAJE

LEFT SIDE

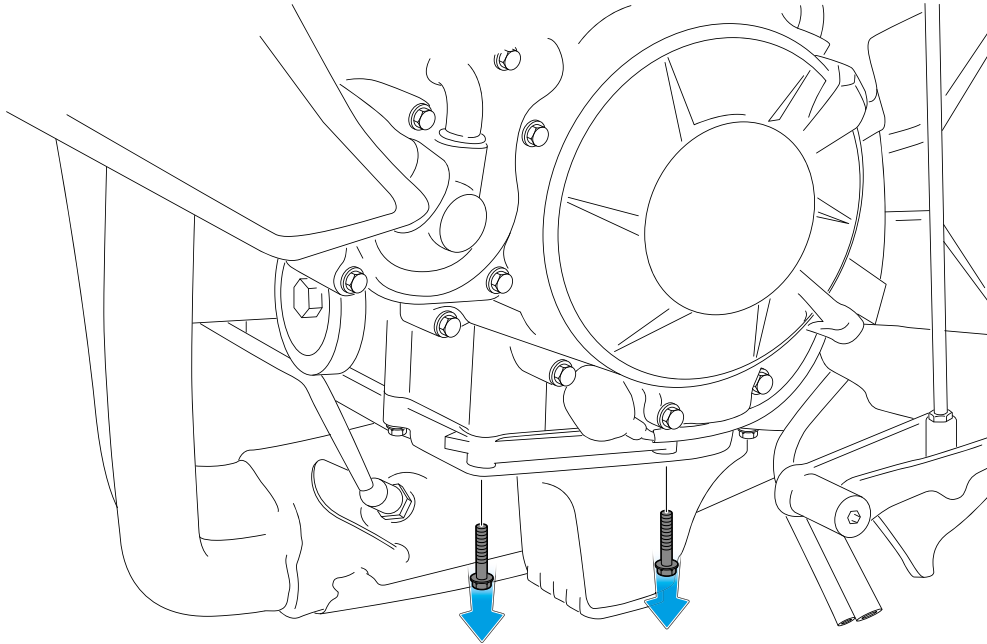

4

ASSEMBLY
MONTAJE

LEFT SIDE

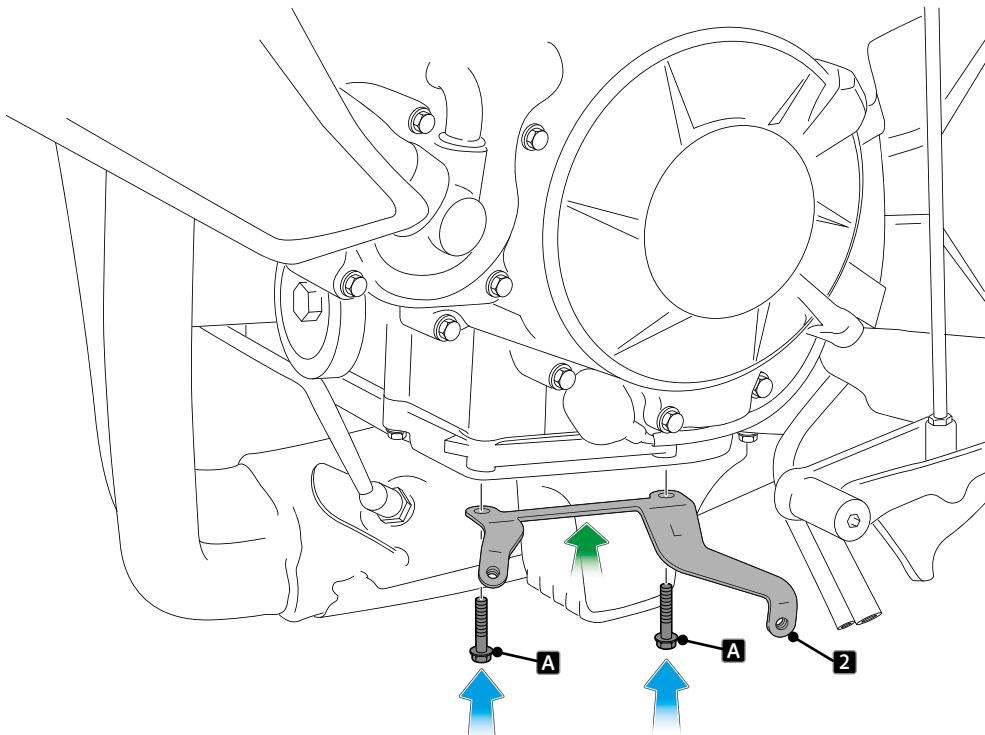

A  Par Apriete - 10 Nm
Tightening Torque - 10 Nm

A PIEZA ORIGINAL
ORIGINAL PART

HONDA CB750 HORNET '23-

INSTRUCCIONES DE MONTAJE - MOUNTING INSTRUCTIONS - MONTAGEANLEITUNG

5

ASSEMBLY
MONTAJE

RIGHT SIDE

WITH ARROW EXHAUST
IT'S NECESSARY TO POSITION
THE OXYGEN SENSOR CABLE

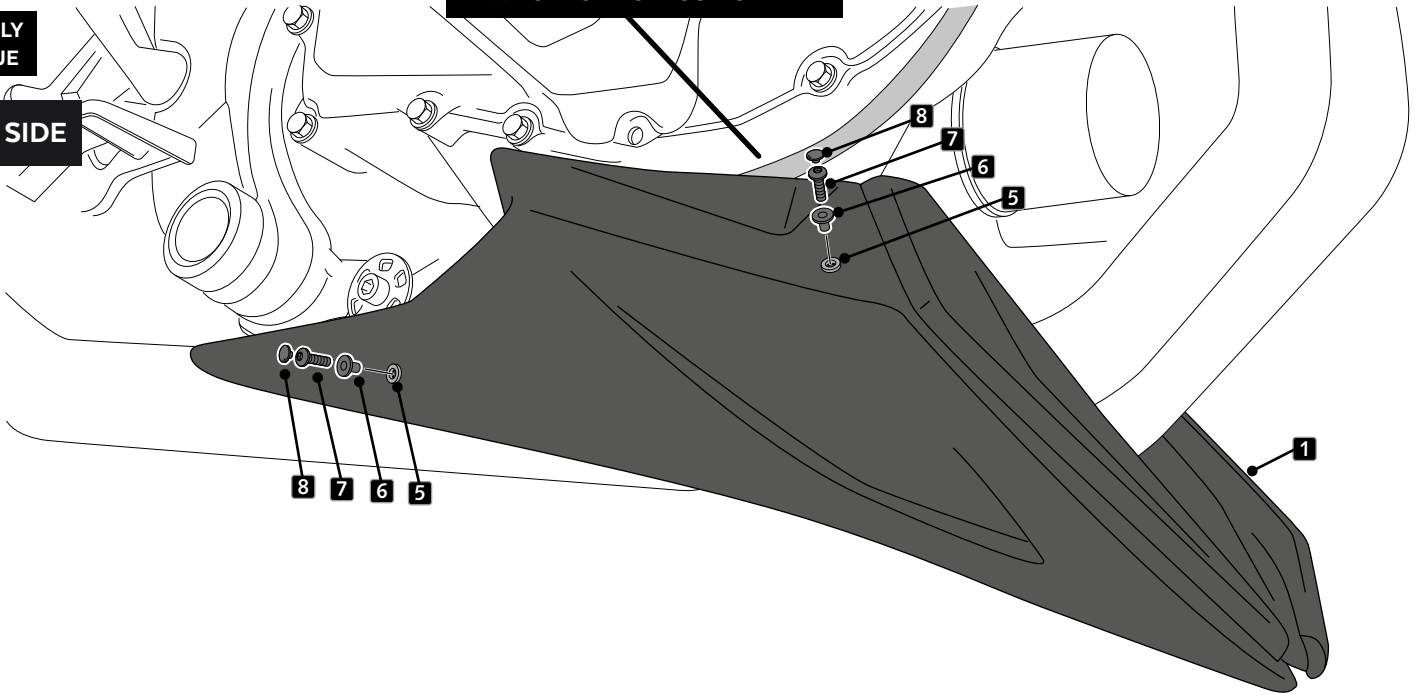

6

ASSEMBLY
MONTAJE

LEFT SIDE

