

HONDA CBR 1000RR FIREBLADE '08-'16

REF 20122N

TAPAS LATERAL IZQUIERDO / LEFT SIDE COVERS



1 Person



30 min



EASY

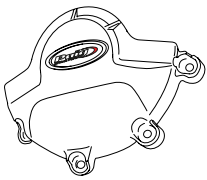
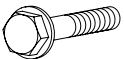

ID.	PIEZA / PART	DESCRIPCIÓN	DESCRIPTION	QTY.	REF.:
1		Tapa izquierda	Left cover	1	CONJUNTO--20122
2		Tornillo M6x35 DIN6921	M6x35 DIN6921 screw	4	-

RECOMENDAMOS MONTAR LOS TORNILLOS APRETANDO UNIFORMEMENTE UNO TRAS OTRO, PARA APRETAR FINALMENTE CON DINAMOMÉTRICA
WE RECOMMEND TO MOUNT THE SCREWS UNIFORMLY TIGHTENING ONE AFTER THE OTHER, TO FINALLY TIGHTEN WITH DYNAMOMETRIC

HONDA CBR 1000RR FIREBLADE '08-'16

REF 20122N

INSTRUCCIONES DE MONTAJE - MOUNTING INSTRUCTIONS - MONTAGEANLEITUNG

1

ASSEMBLY
MONTAJE

2



12,00 N/m - Par de apriete
8,91 lb/ft - Tightening torque

TUBE



8mm

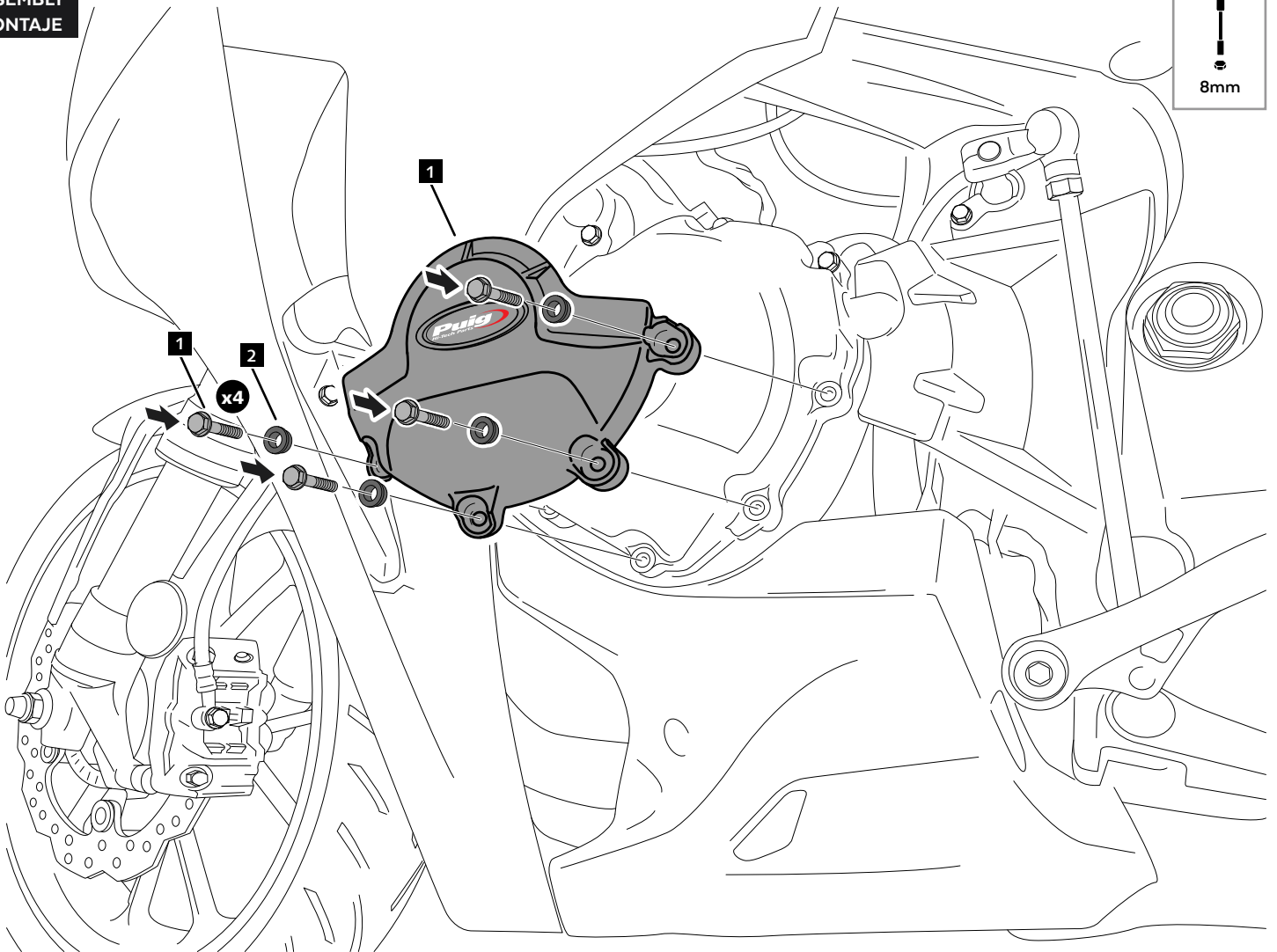

**CONSULTAR EN NUESTRA PAGINA WEB LA DISPONIBILIDAD DEL VIDEO DE MONTAJE DE ESTA REFERENCIA.
CONSULT OUR WEBSITE THE VIDEO MOUNT AVAILABILITY OF THIS REFERENCE.**



HONDA CBR 1000RR FIREBLADE '08-'16

REF 20122N

TAPAS LATERAL DERECHO / RIGHT SIDE COVERS



1 Person





30 min



EASY

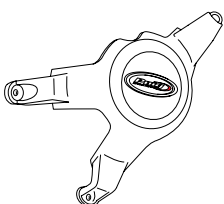

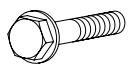
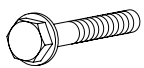
ID.	PIEZA / PART	DESCRIPCIÓN	DESCRIPTION	QTY.	REF.:
1		Tapa derecha 1	Right cover 1	1	CONJUNTO--20122N
2		Tapa derecha 2	Right cover 2	1	CONJUNTO--20122N
3		Tornillo M6x35 DIN6921	M6x35 DIN6921 screw	4	-
4		Tornillo M6x40 DIN6921	M6x40 DIN6921 screw	3	-

RECOMENDAMOS MONTAR LOS TORNILLOS APRETANDO UNIFORMEMENTE UNO TRAS OTRO, PARA APRETAR FINALMENTE CON DINAMOMÉTRICA
WE RECOMMEND TO MOUNT THE SCREWS UNIFORMLY TIGHTENING ONE AFTER THE OTHER, TO FINALLY TIGHTEN WITH DYNAMOMETRIC

HONDA CBR 1000RR FIREBLADE '08-'16

REF 20122N

INSTRUCCIONES DE MONTAJE - MOUNTING INSTRUCTIONS - MONTAGEANLEITUNG

1

ASSEMBLY
MONTAJE

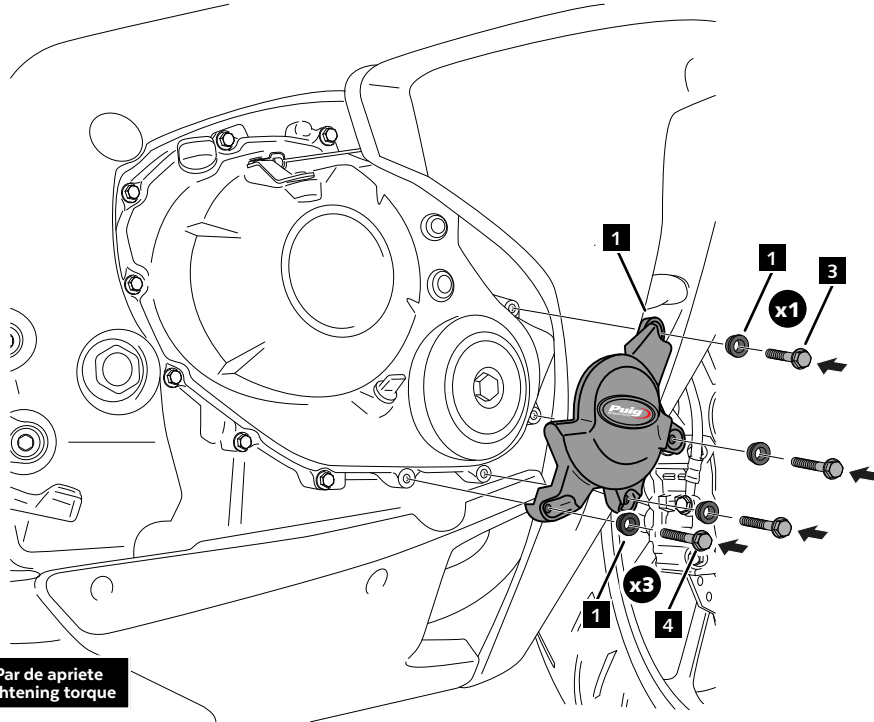

3-4 12,00 N/m - Par de apriete
8,91 lb/ft - Tightening torque

2

ASSEMBLY
MONTAJE

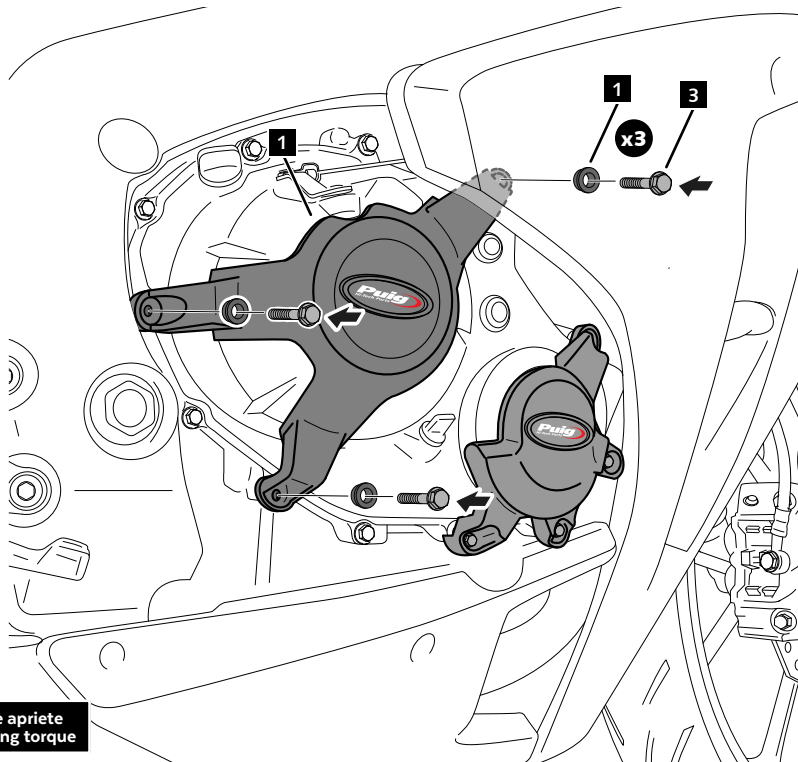

3 12,00 N/m - Par de apriete
8,91 lb/ft - Tightening torque