

YAMAHA XV950R '14-

M O U N T I N I N S T R U C T I O N S

REF 21094







SEMIFAIRING ANARCHY MODEL

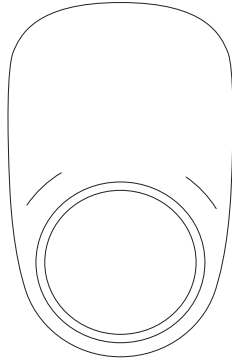

ALLEN

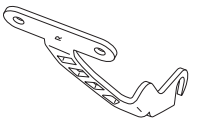
Nº 3
Nº 6



| ID | PIEZA/PART | DESCRIPCIÓN | DESCRIPTION | QTY | REF |
|----|---|-----------------------------------|--------------------------------|-----|-----------------|
| 1 |  | Semicarenado | Semifairing | 1 | 10896N |
| 2 |  | Soporte izquierdo (L) | Left support (L) | 1 | SOP2P2L-CUP0005 |
| 3 |  | Soporte derecho (R) | Right support (R) | 1 | SOP2P2R-CUP0005 |
| 4 |  | Silentblock Ø9 xØ6 x8mm | Ø9 xØ6 x8mm silentblock | 4 | AROPASACABLES-3 |
| 5 |  | Casquillo con valona Ø12xØ6,8x7,3 | Ø12xØ6,8x7,3 bush with flange | 4 | CASQUI-1A---750 |
| 6 |  | Tornillo Allen M5x16 Ø11 ISO 7380 | M5x16 Ø11 ISO 7380 Allen screw | 4 | TORNI-I7380-493 |
| 7 |  | Tapón tornillo M5 | M5 screw cap | 4 | TAPON-----85 |

YAMAHA XV950R '14-

INSTRUCCIONES DE MONTAJE - MOUNTING INSTRUCTIONS - MONTAGEANLEITUNG

1

DISASSEMBLY
DESMONTAJE

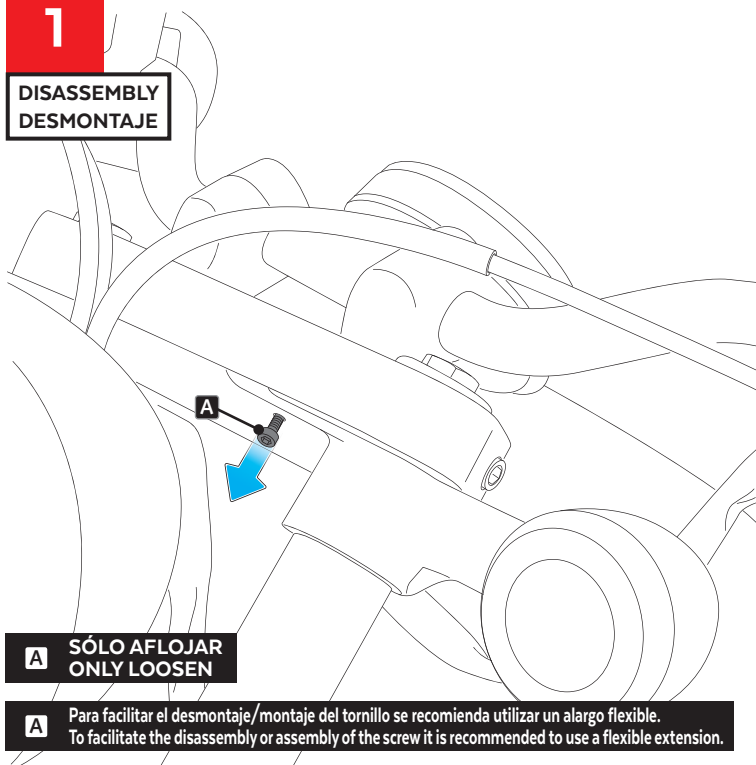

A SÓLO AFLOJAR
ONLY LOOSEN

A Para facilitar el desmontaje/montaje del tornillo se recomienda utilizar un alargó flexible.
To facilitate the disassembly or assembly of the screw it is recommended to use a flexible extension.

2

ASSEMBLY
MONTAJE

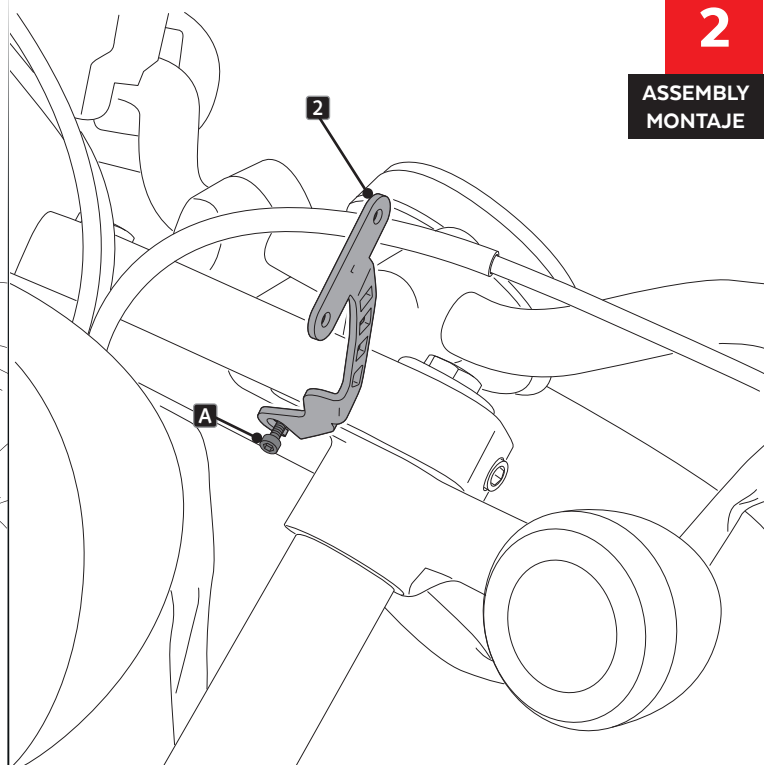

3

DISASSEMBLY
DESMONTAJE

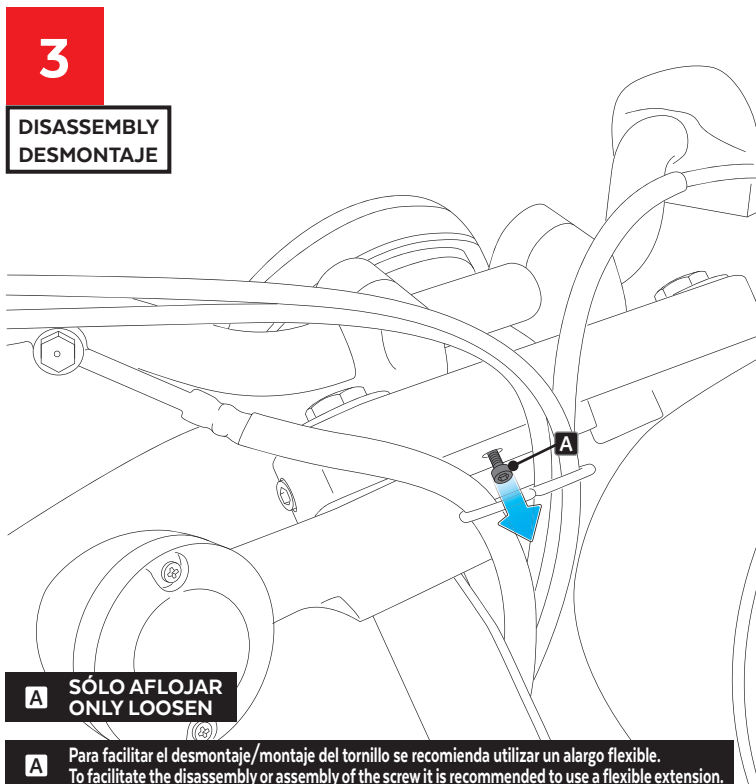

A SÓLO AFLOJAR
ONLY LOOSEN

A Para facilitar el desmontaje/montaje del tornillo se recomienda utilizar un alargó flexible.
To facilitate the disassembly or assembly of the screw it is recommended to use a flexible extension.

4

ASSEMBLY
MONTAJE

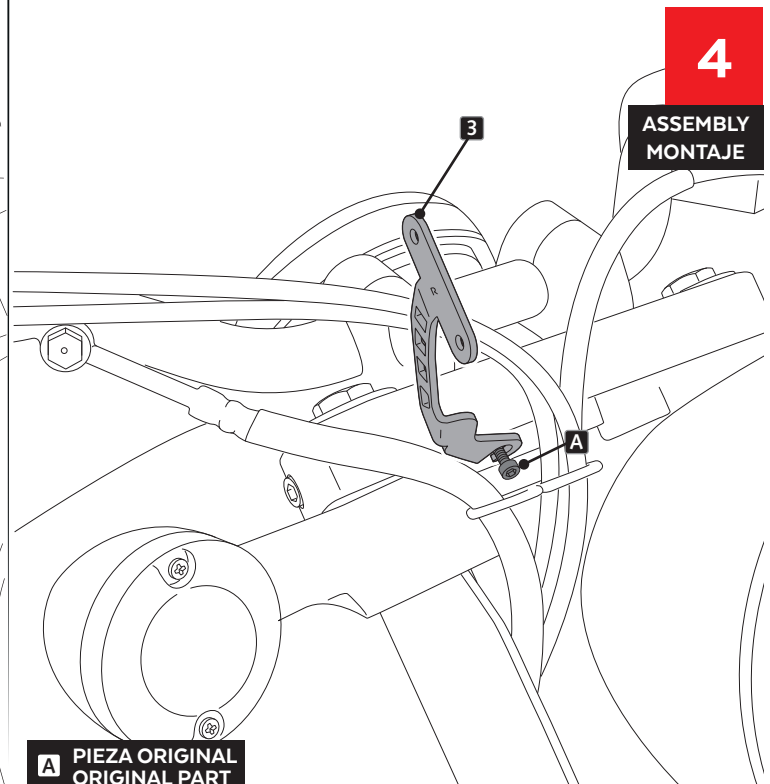

A PIEZA ORIGINAL
ORIGINAL PART

YAMAHA XV950R '14-

INSTRUCCIONES DE MONTAJE - MOUNTING INSTRUCTIONS - MONTAGEANLEITUNG

5

ASSEMBLY
MONTAJE

